

6.1 Bestückungsplan Schritt 1

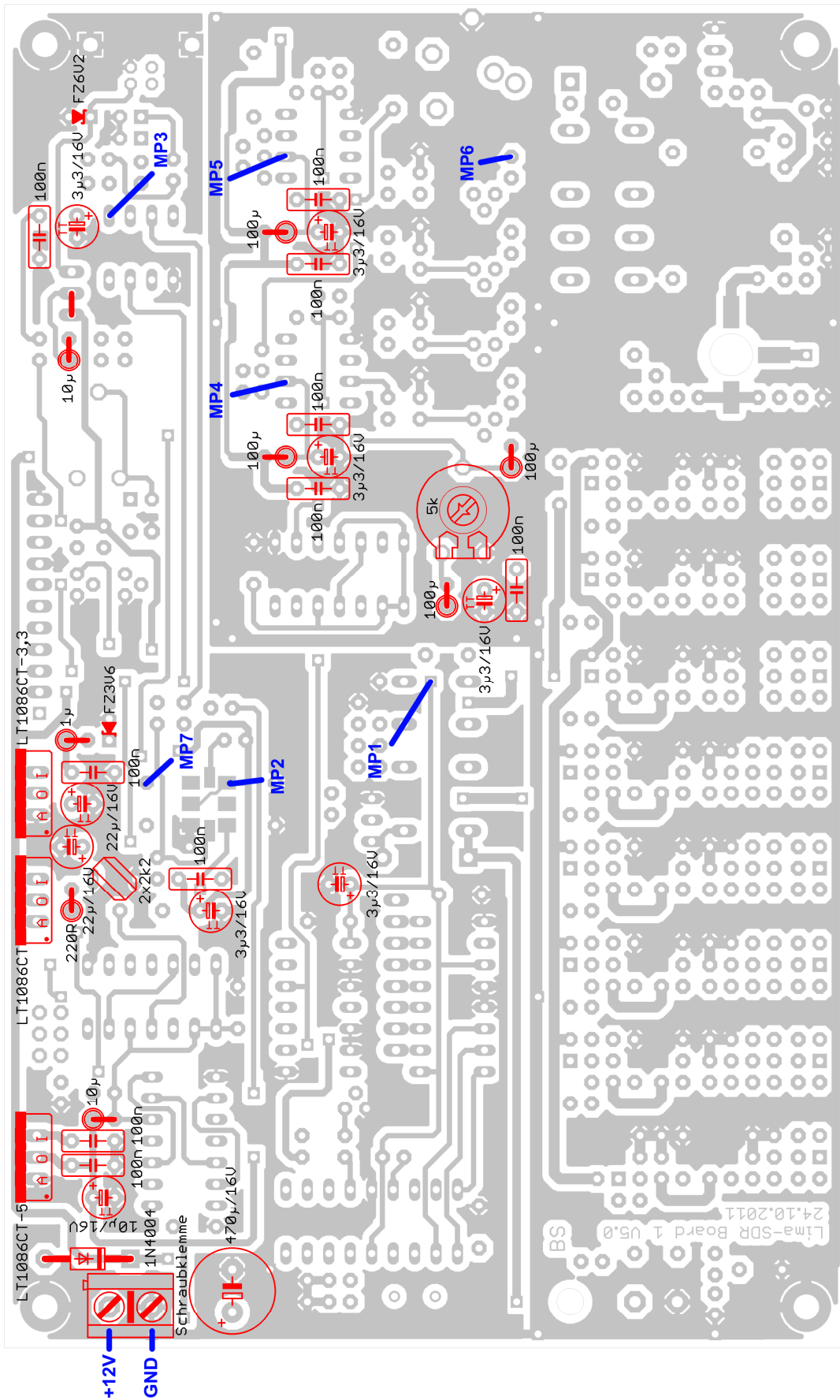

6.2 Bestückungsplan Schritt 2

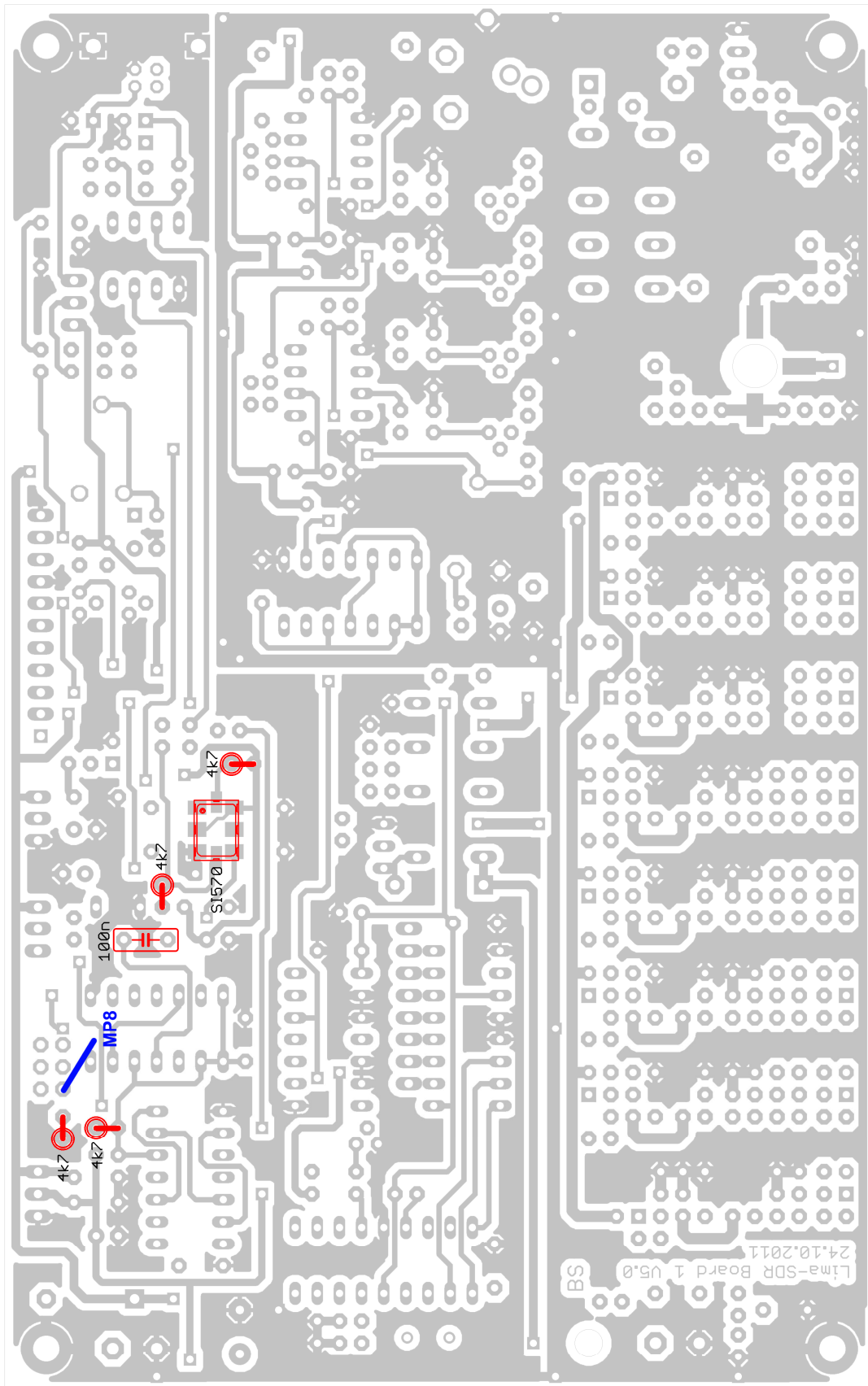

6.3 Bestückungsplan Schritt 3

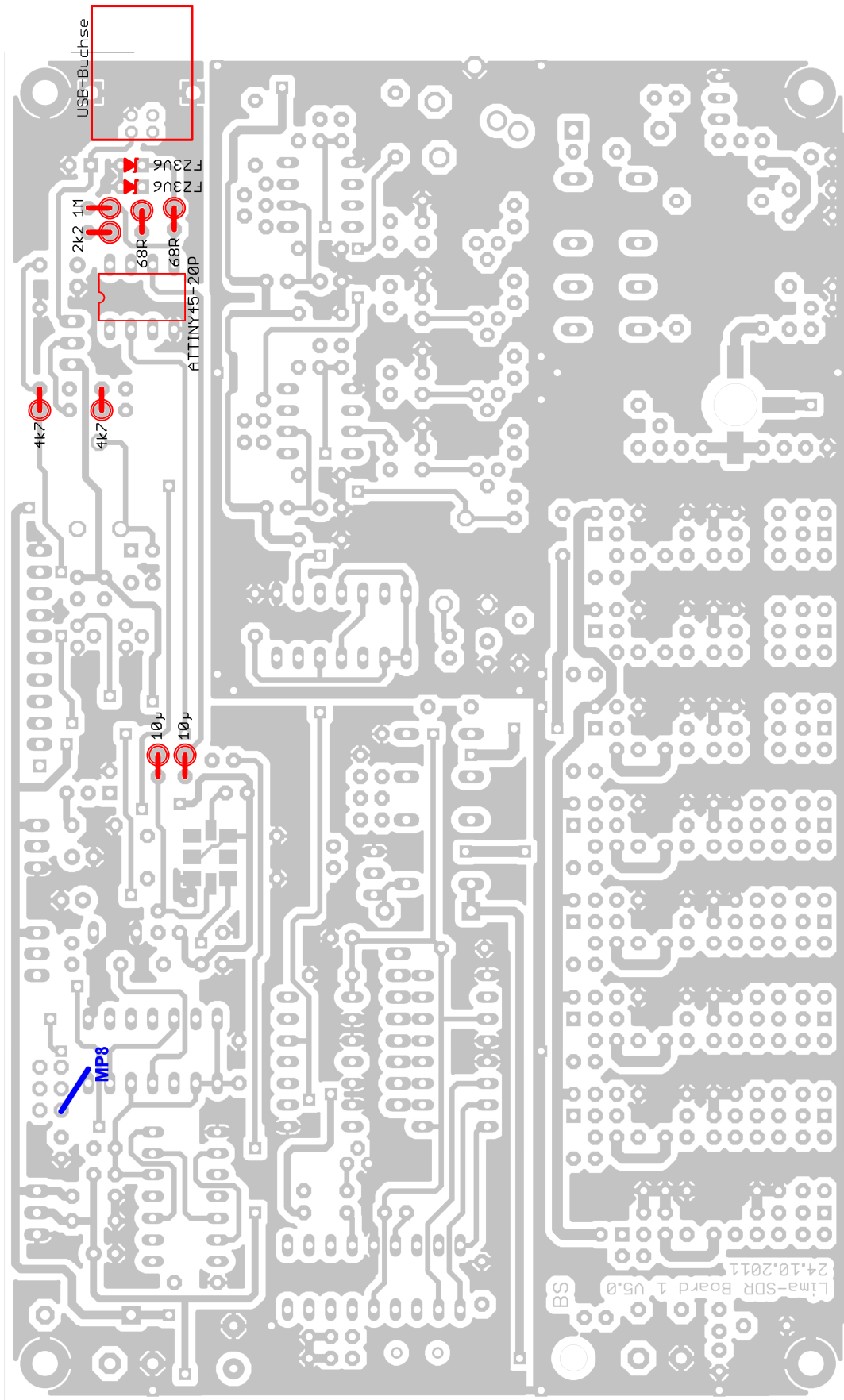

6.4 Bestückungsplan Schritt 4

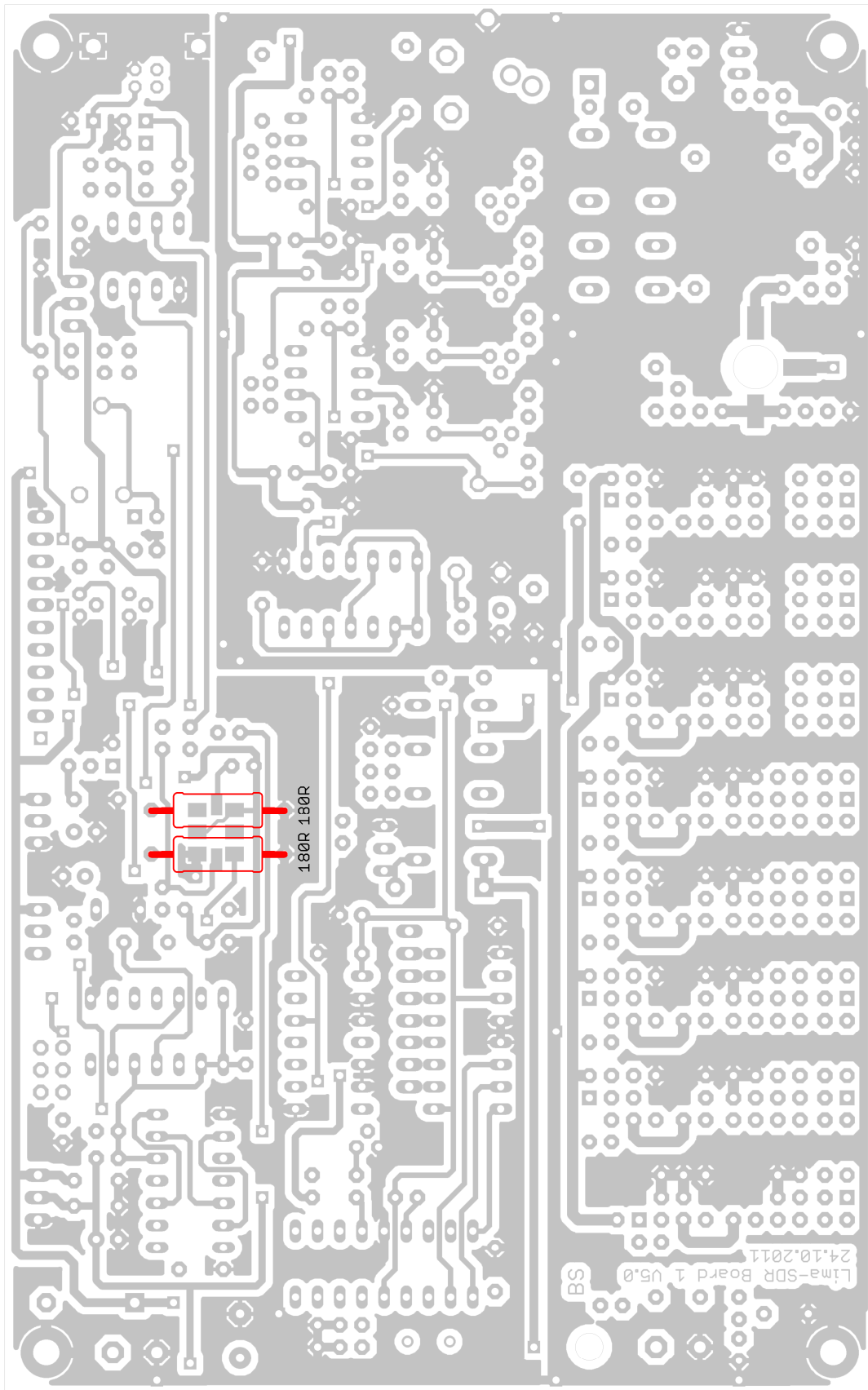

6.5 Bestückungsplan Schritt 5

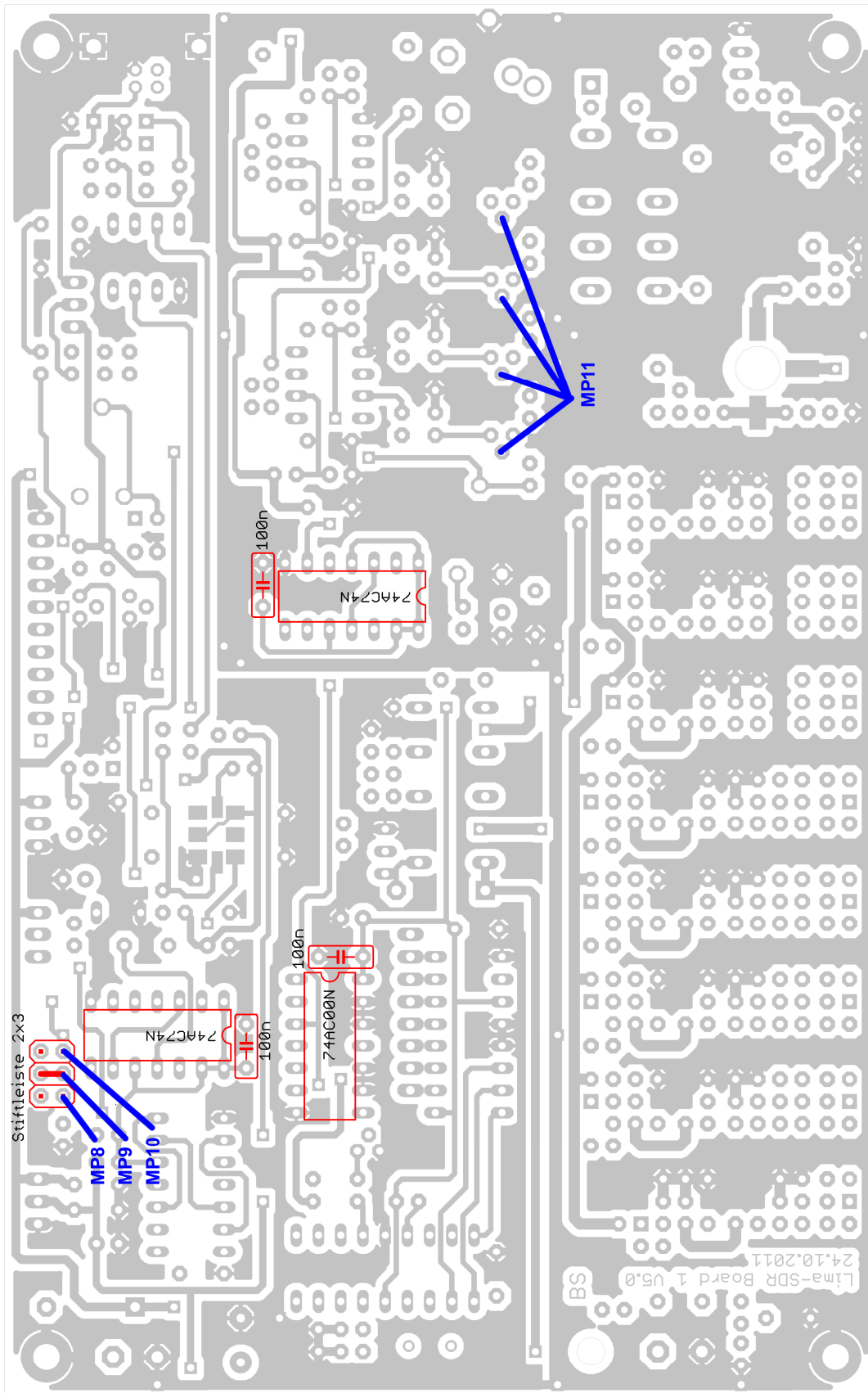

6.6 Bestückungsplan Schritt 6

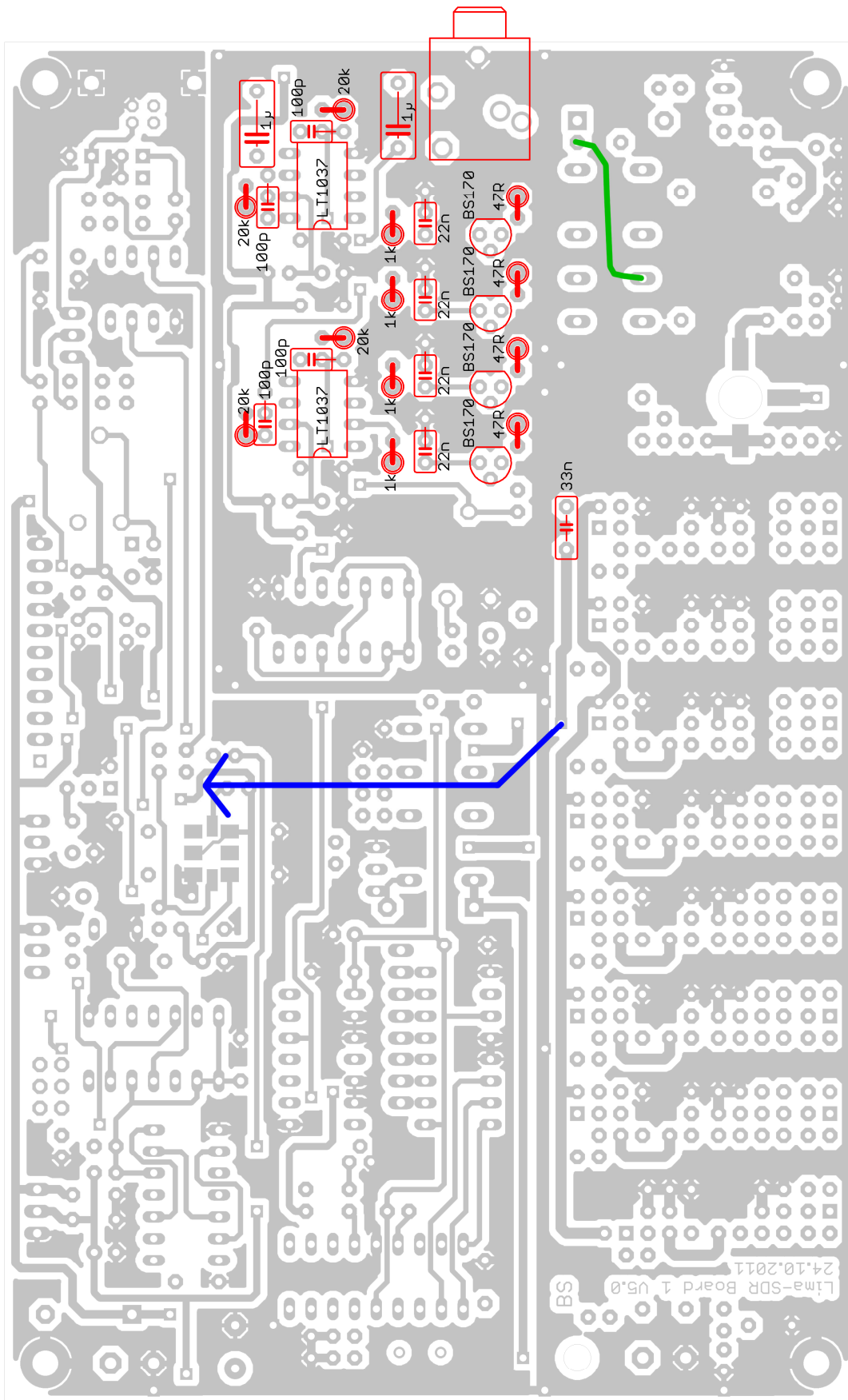

6.7 Bestückungsplan Schritt 7

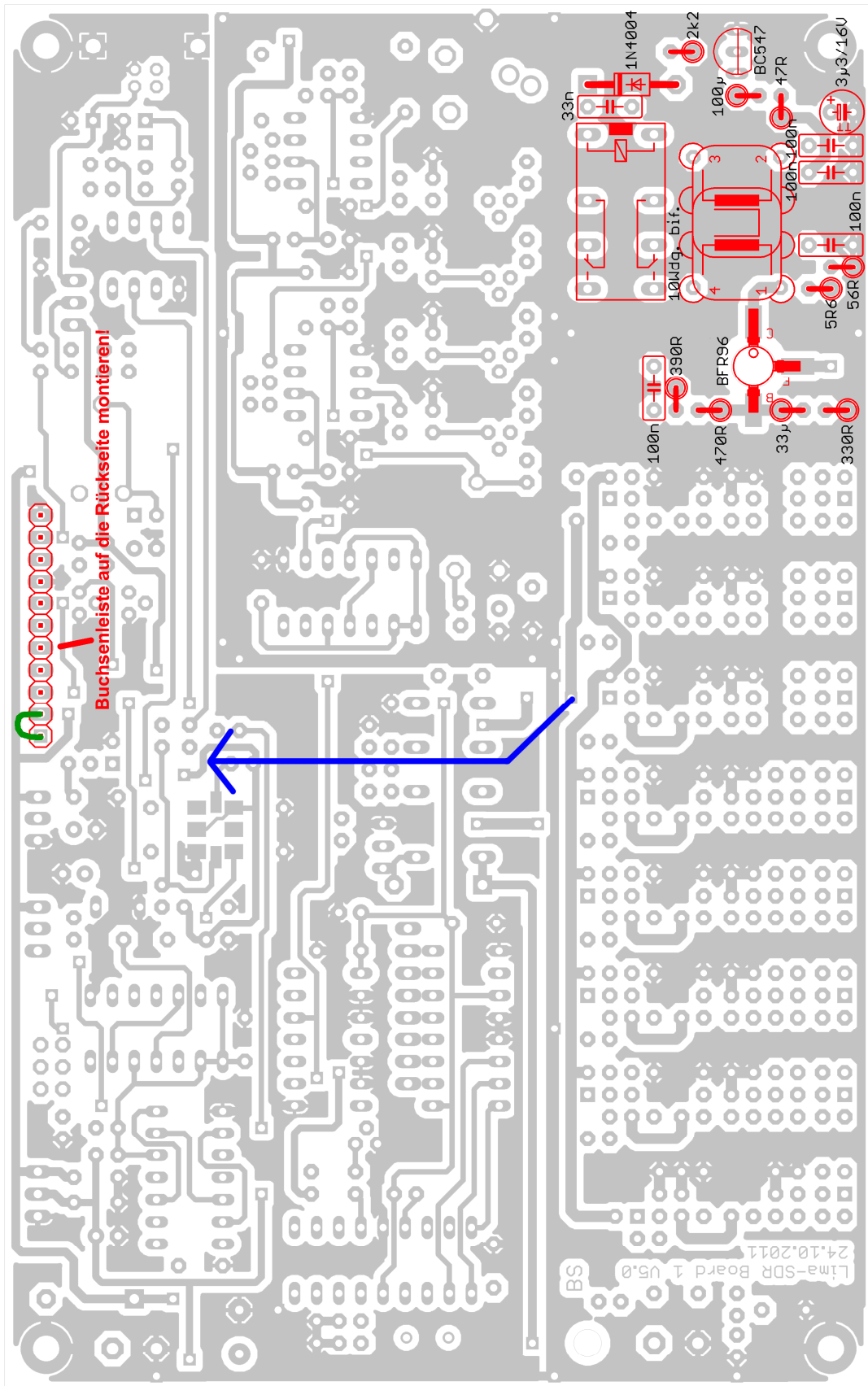

6.8 Bestückungsplan Schritt 8

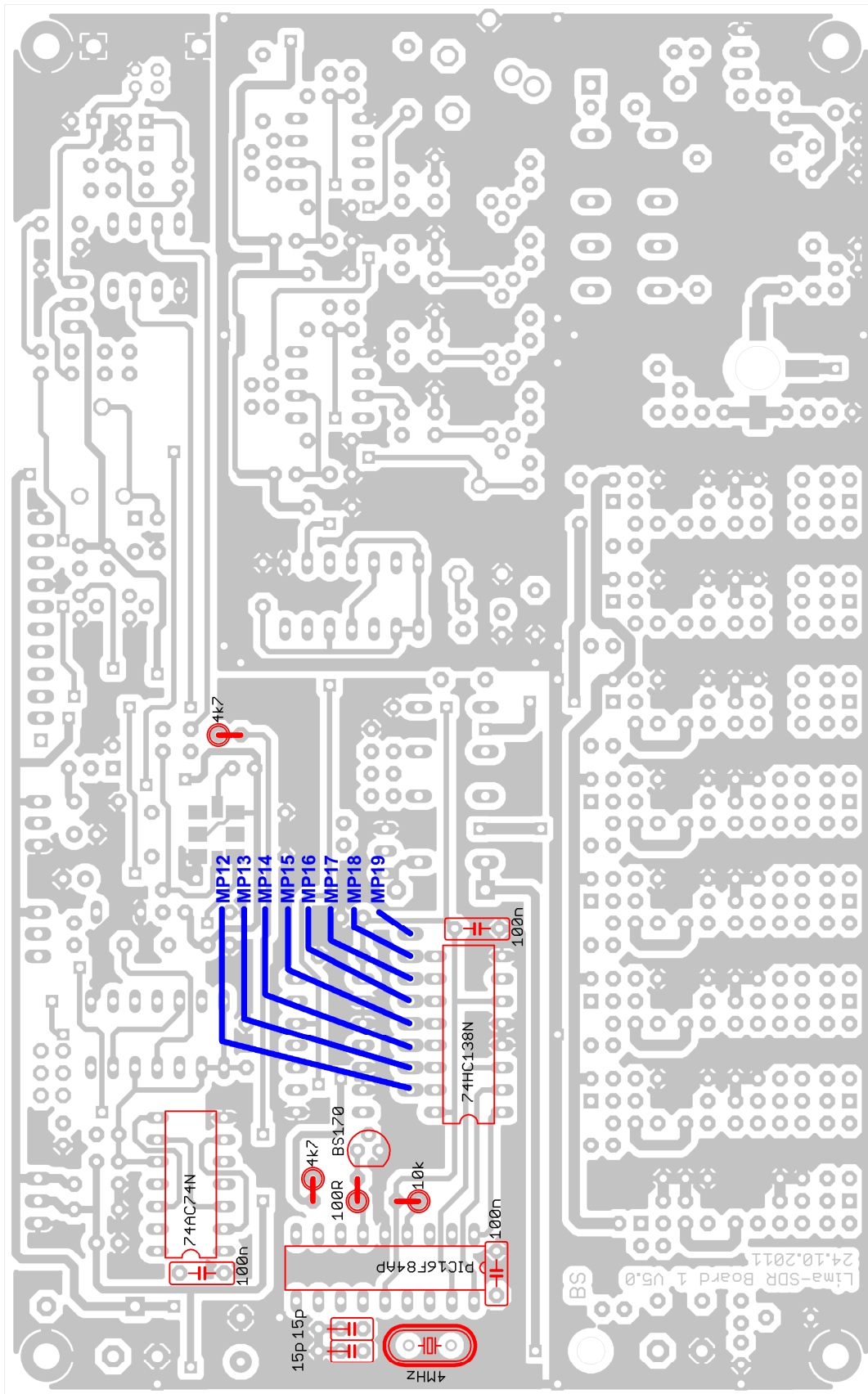

6.9 Bestückungsplan Schritt 9

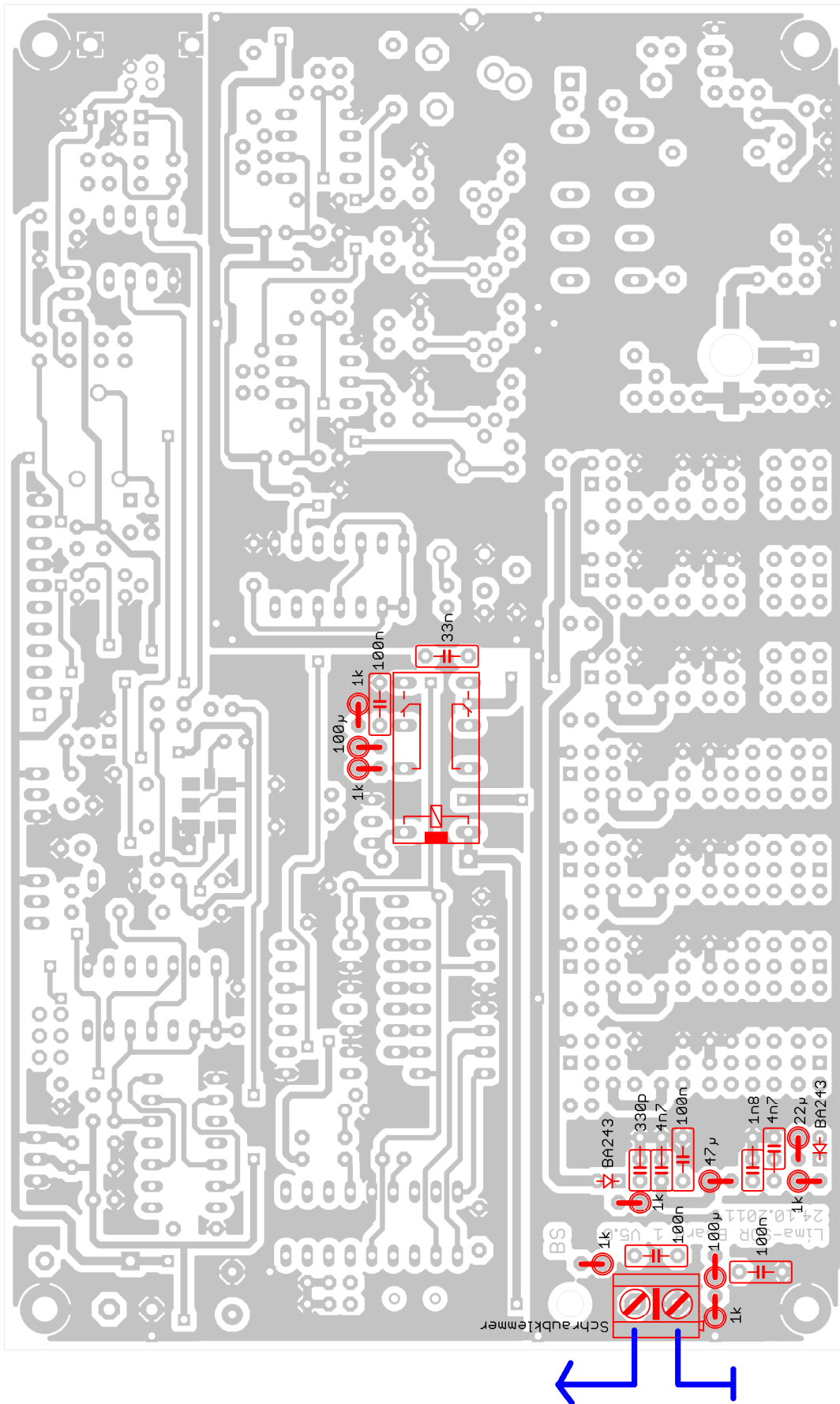

6.10 Bestückungsplan Schritt 10

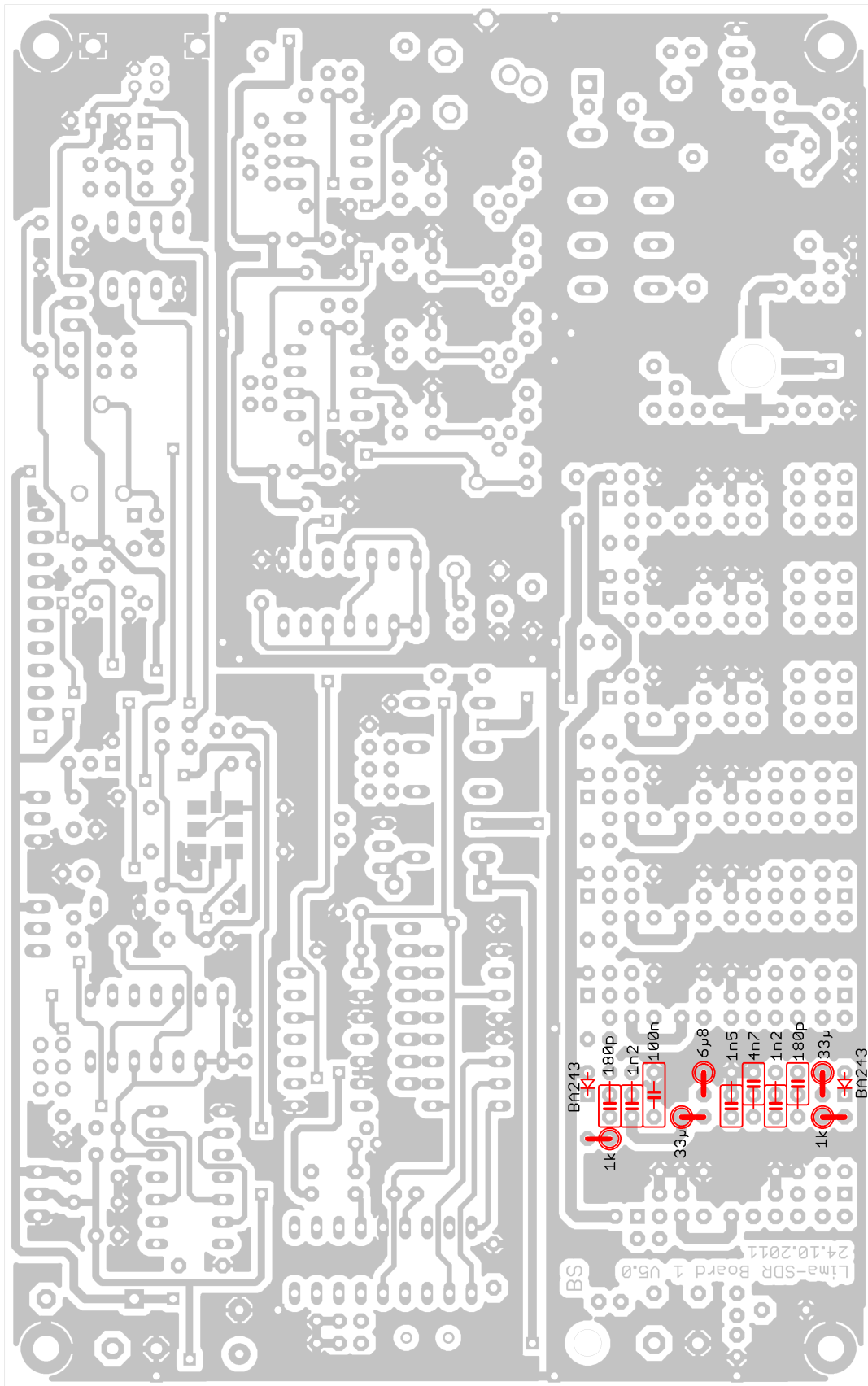

6.11 Bestückungsplan Schritt 11

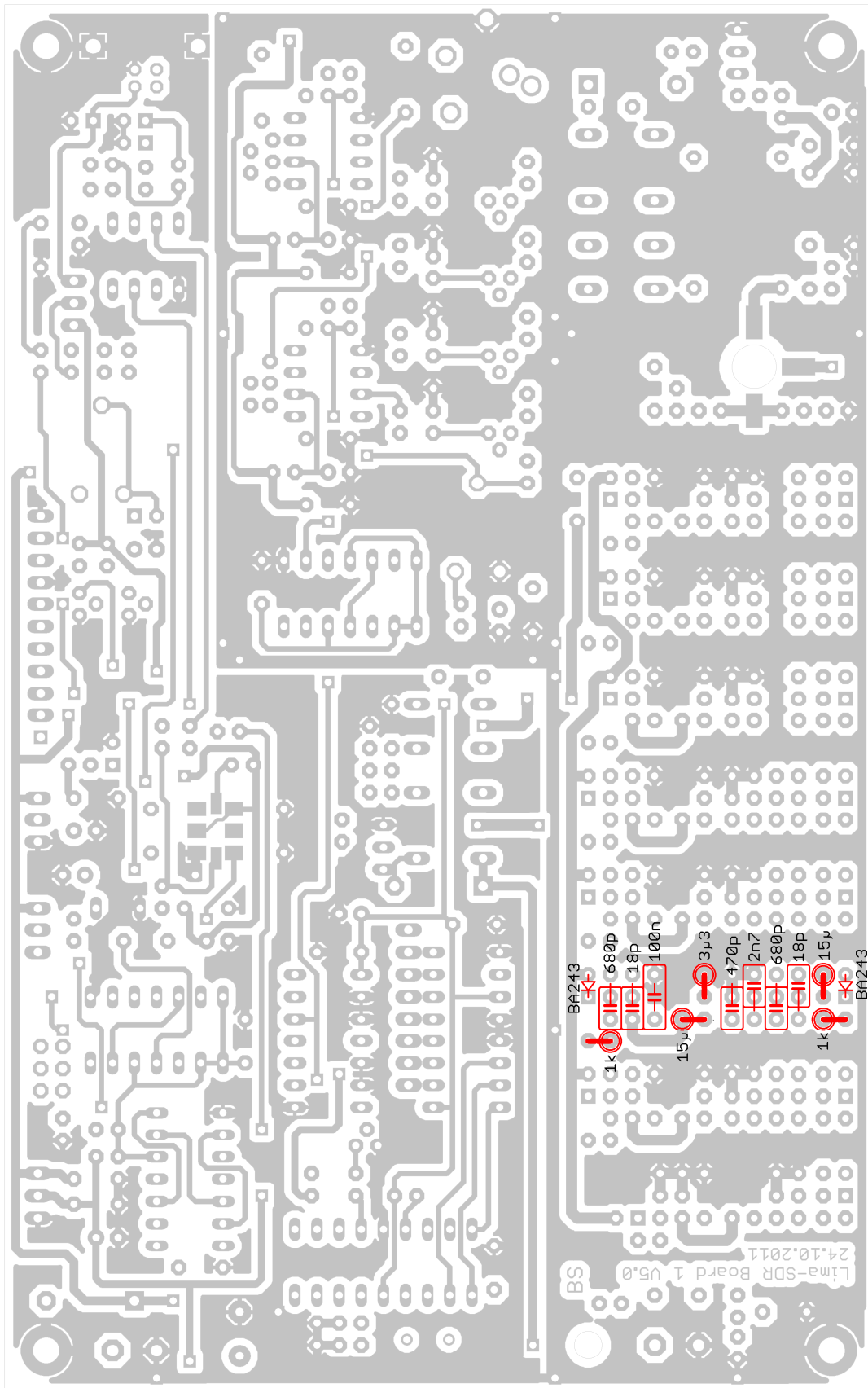

6.12 Bestückungsplan Schritt 12

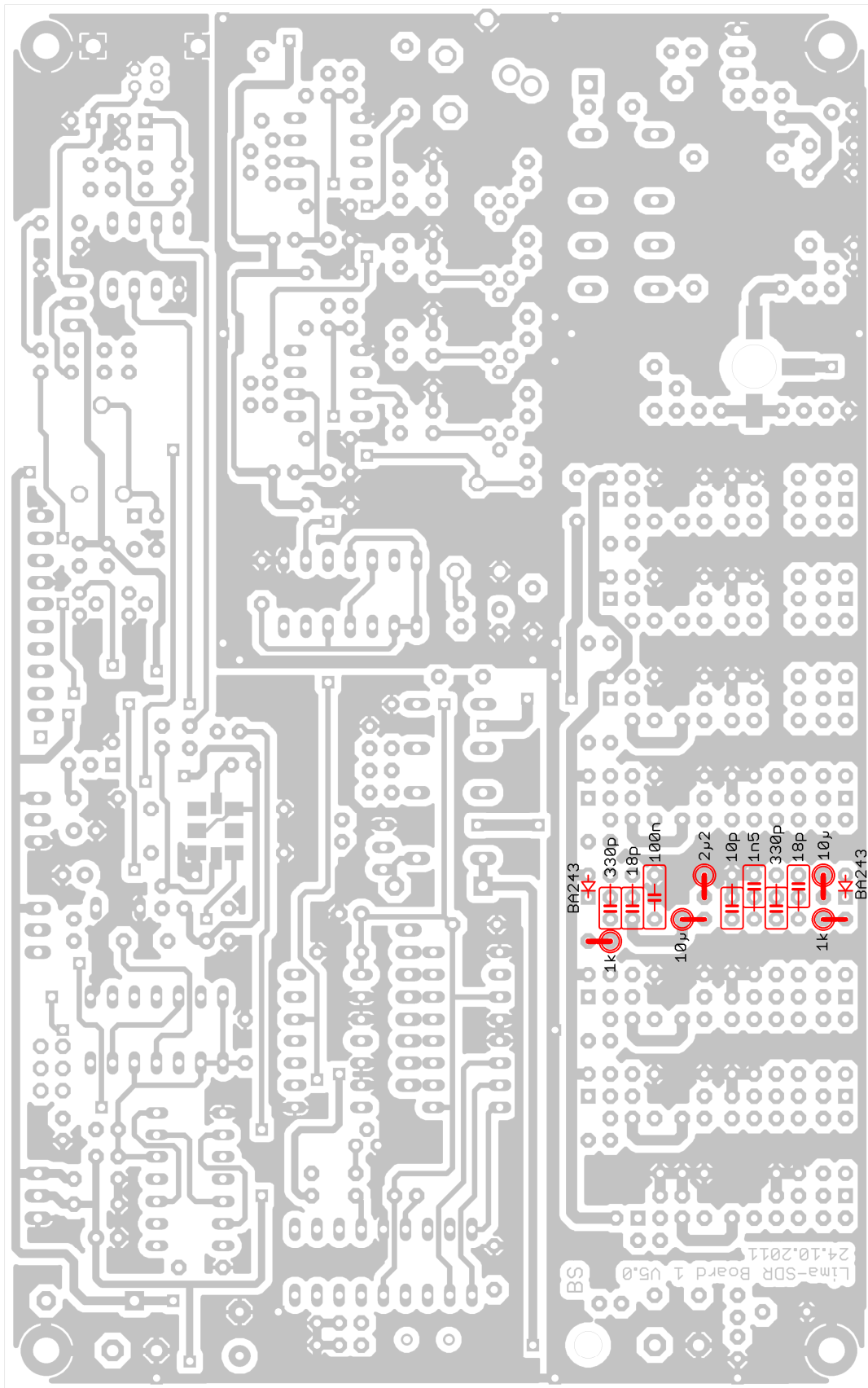

6.13 Bestückungsplan Schritt 13

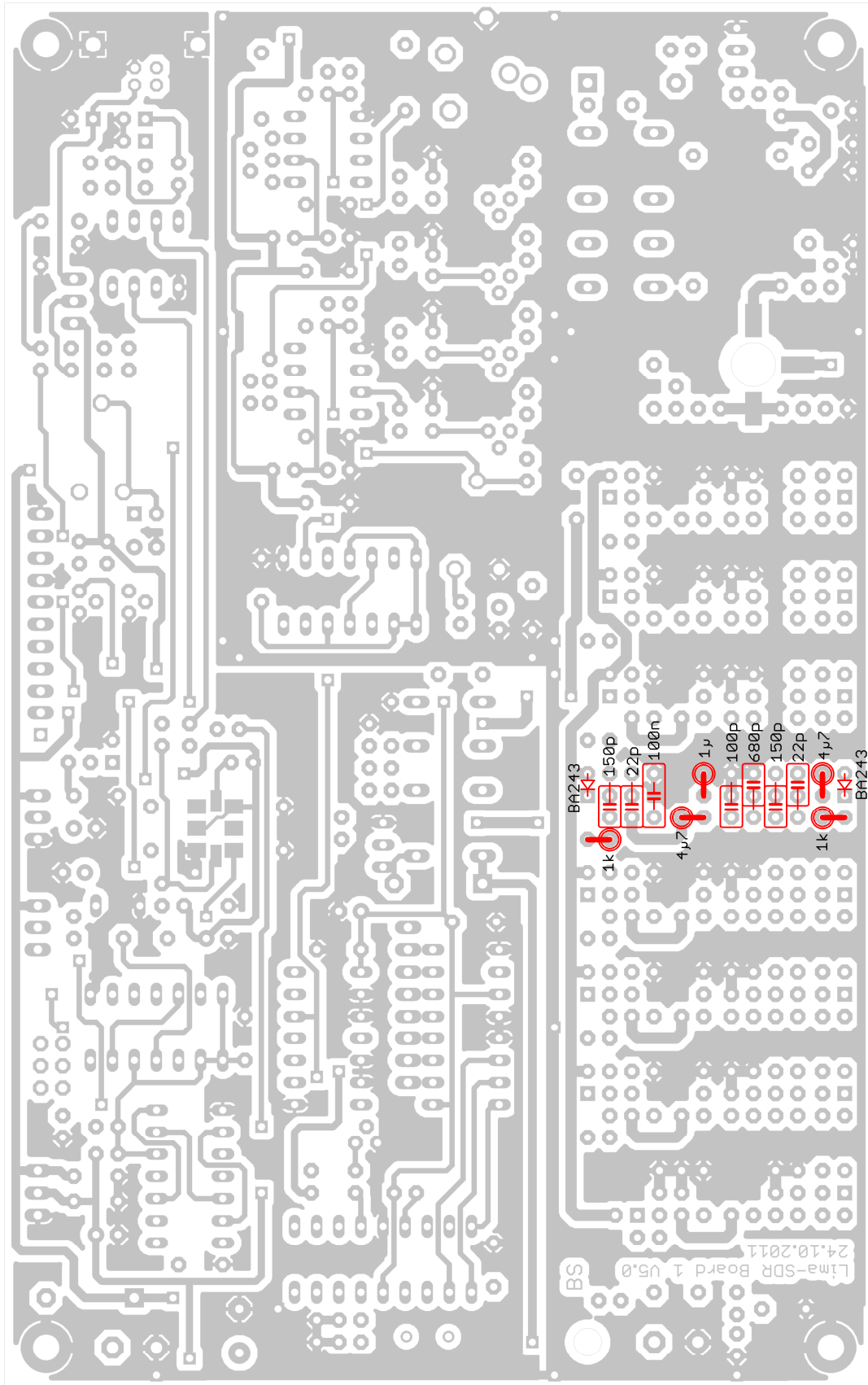

6.14 Bestückungsplan Schritt 14

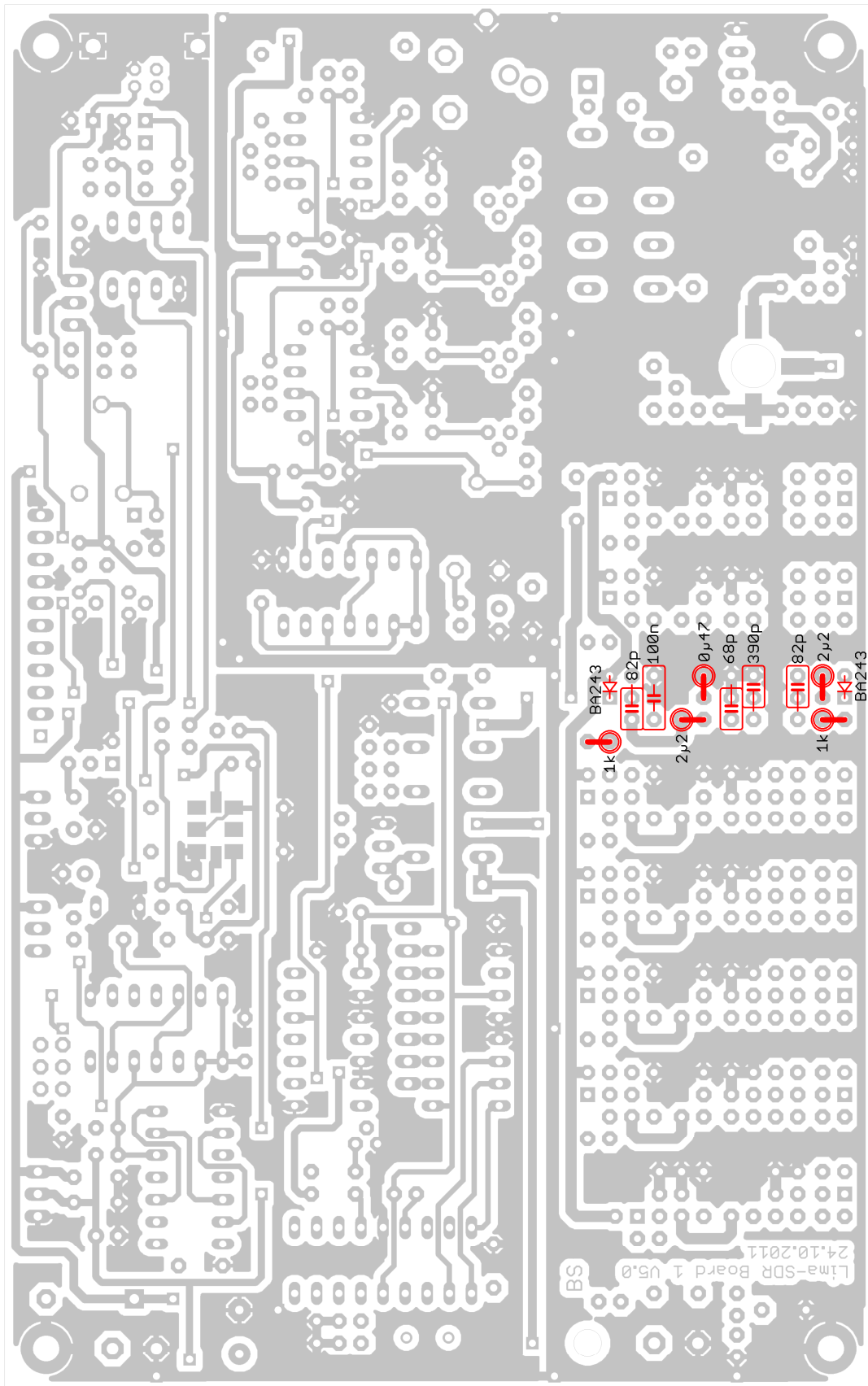

6.15 Bestückungsplan Schritt 15

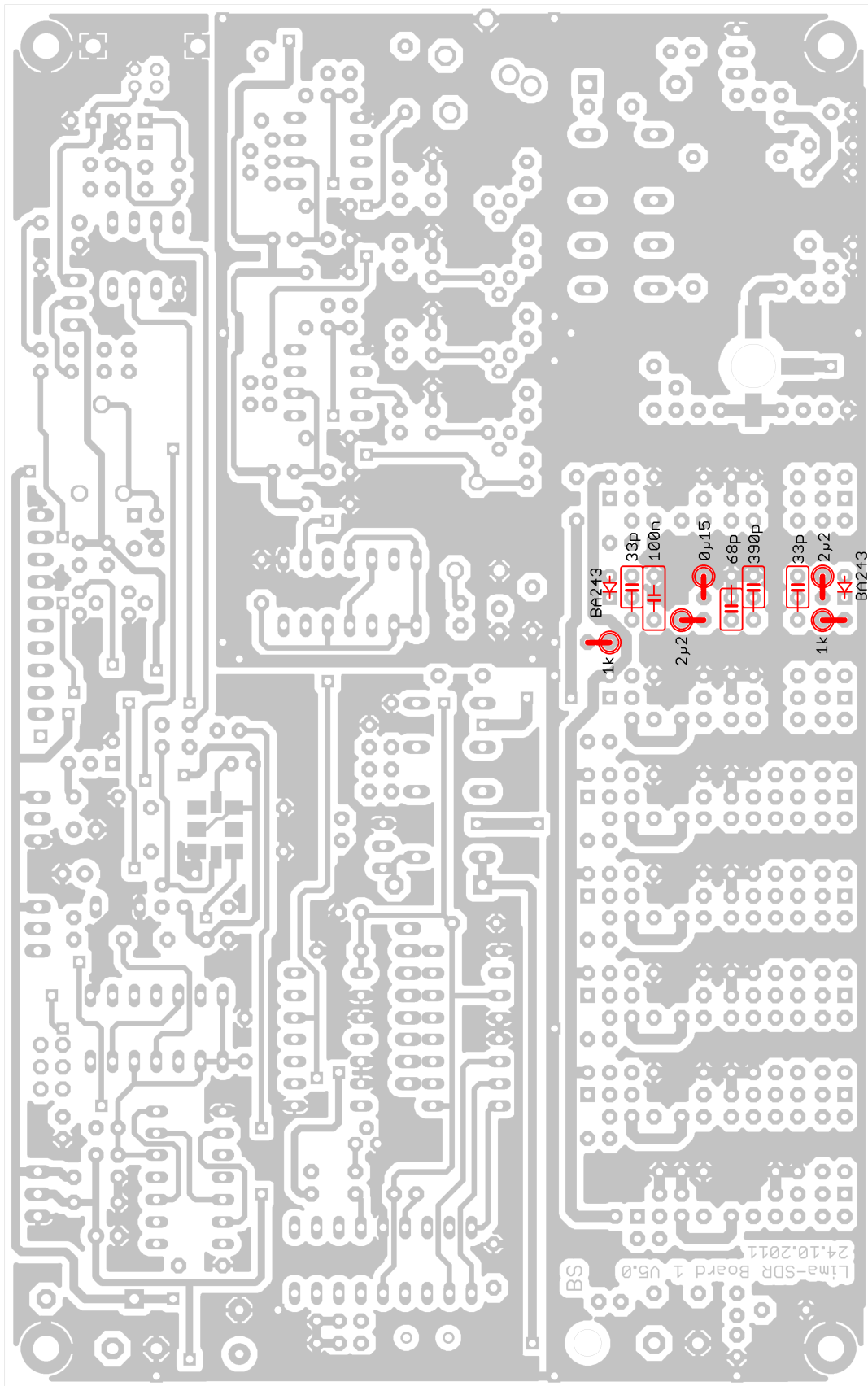

6.16 Bestückungsplan Schritt 16

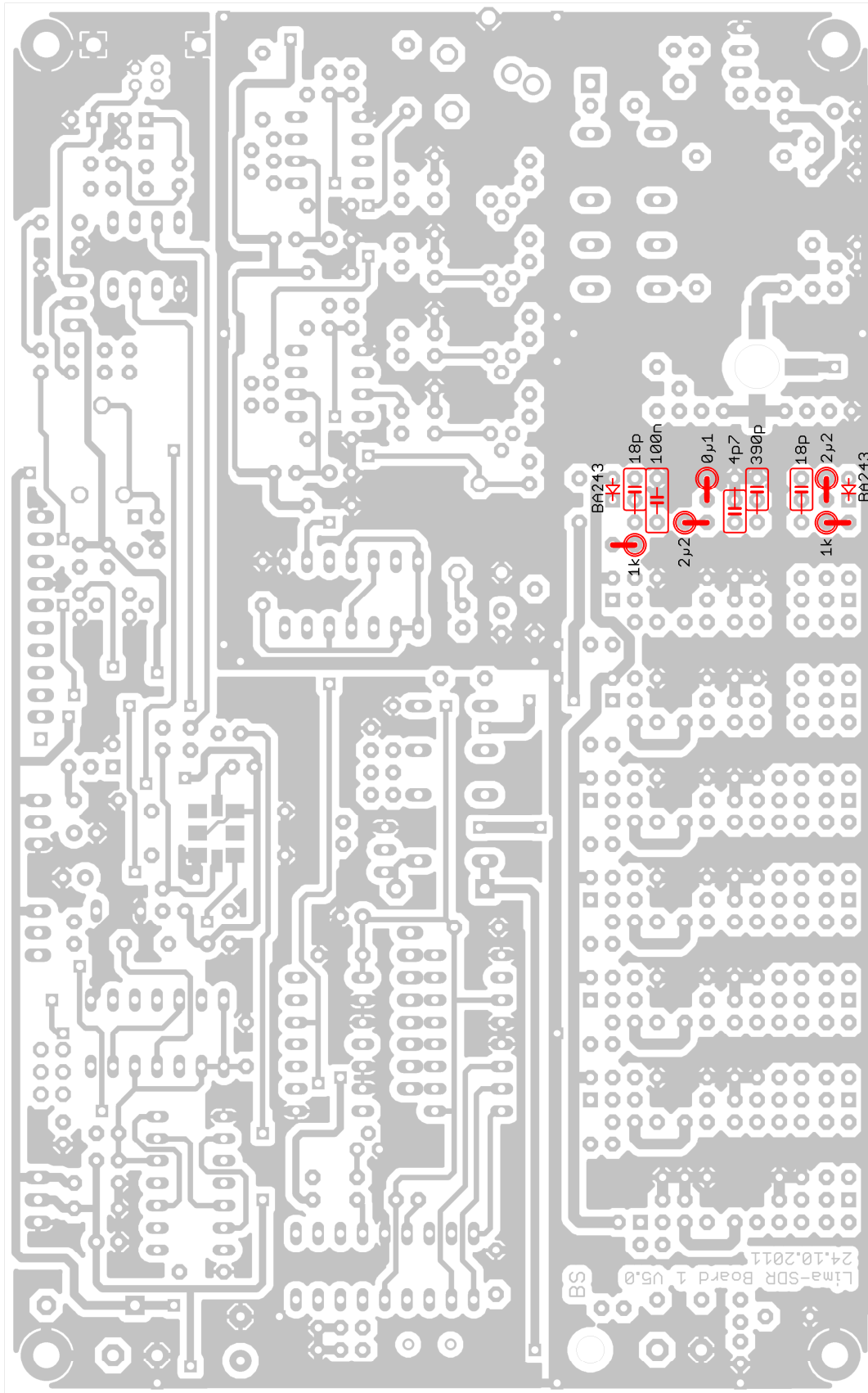

6.17 Bestückungsplan Schritt 17

